











 9.5°

DMC 1350 kg
  678 kg
  672 kg



 5033 mm



 1992 mm
  6371 mm
  2159 mm







ZNACZENIE IKON / THE MEANING OF THE ICONS BEDEUTUNG VON SYMBOLEN / LA SIGNIFICATION DES ICÔNES

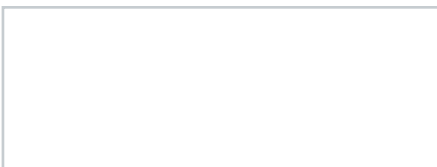
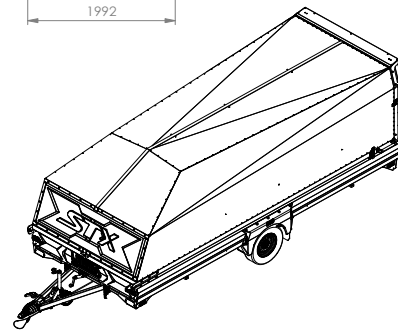
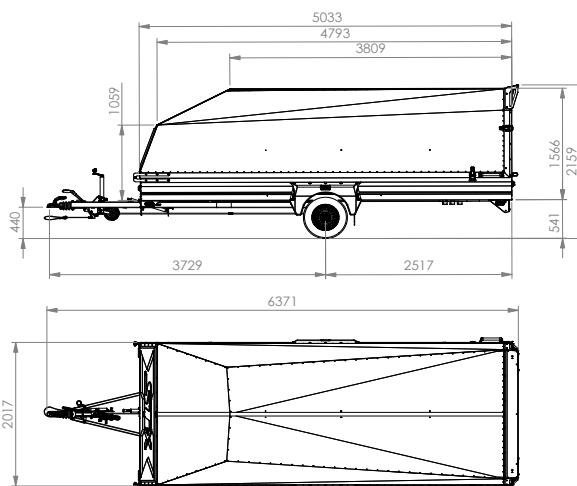

Dopuszczalna masa całkowita [kg]
Gross vehicle weight [kg]
Zulässiges Gesamtgewicht [kg]
Poids total autorisé en charge [kg]



Ładowność [kg]
Load capacity [kg]
Nutzlast [kg]
Charge utile [kg]



Masa własna [kg]
Complete kerb weight [kg]
Leergewicht [kg]
Poids à vide [kg]



Rodzaj osi: Hamowana
Axles type: Braked
Typ der Achse: Gebremst
Type d'essieux: Freiné



Rodzaj kół
Wheels type
Typ der Räder
Type de roues



Liczba osi [sztuk]
Number of axles
Anzahl der Achsen
Nombre d'essieux



Kąt najazdu
Drive-on angle
Neigungswinkel
Angle d'attaque



Szerokość
Width
Breite
Largeur



Długość
Length
Länge
Longueur



Wysokość
Height
Höhe
Hauteur



Maksymalna długość powierzchni ładunku [mm]
Maximum length of the loading surface [mm]
Maximale Länge der Ladefläche [mm]
Longueur maximale de la surface de chargement [mm]



Maksymalna szerokość powierzchni ładunku [mm]
Maximum width of the loading surface [mm]
Maximale Breite der Ladefläche [mm]
Largeur maximale de la surface de chargement [mm]



WYPOSAŻENIE STANDARDOWE / STANDARD EQUIPMENT STANDARD AUSRÜSTUNG / ÉQUIPEMENT STANDARD



Hamulec najazdowy
Overrun brake
Auflaufbremse
Frein à inertie



Hamulec postojowy
Parking brake
Feststellbremse
Frein de stationnement



Koło podporowe
Support wheel
Stützrad
Roue jockey



Tyłne lampy LED
LED rear lamps
LED-Heckleuchten
Feux LED arrière



Wodoodporna i antypoślizgowa sklejka podłogowa
Waterproof and non-slip floor plywood
Wasserfestes und rutschfestes Bodensperrholz
Plancher en contreplaqué imperméable et antidérapant



Uchwyty mocowane do burt
Handles attached to the sides
An den Seiten angebrachte Griffe
Poignées fixées sur les côtés



WYPOSAŻENIE DODATKOWE / ADDITIONAL EQUIPMENT OPTIONALES ZUBEHÖR / ÉQUIPEMENT SUPPLÉMENTAIRE



Zabezpieczenie antykradzieżowe
Anti-theft protection
Diebstahlschutz
Protection anti-vol



Możliwość pomalowania na białe lub czarno
Can be painted white or black
Kann weiß oder schwarz lackiert werden
Peut être peint en blanc ou en noir



Koło zapasowe z mocowaniem
Spare wheel with mountings
Ersatzrad mit Befestigung
Roue de secours avec fixation



Amortyzatory do osi
Axle shock absorbers
Achsstoßdämpfer
Amortisseurs d'essieux